

HEWLETT PACKARD
H
E
W
L
E
T
T
P
A
C
K
A
R
D
C
O
R
P
O
R
A
T
I
O
N

712B

REGULATED POWER SUPPLY

SERIALS PREFIXED : 002-

OPERATING AND SERVICING MANUAL



OPERATING AND SERVICING MANUAL



MODEL 712B
POWER SUPPLY
SERIAL PREFIX: 002-



TABLE OF SPECIFICATIONS

OUTPUT VOLTAGES

DC REGULATED HIGH VOLTAGE: 0 to +500 volts (without switching), 200 ma maximum load.
 DC REGULATED FIXED BIAS: -300 volts, 50 ma maximum load.
 DC VARIABLE BIAS: 0 to -150 volts, 5 ma maximum load.
 AC UNREGULATED: 6.3 volts CT, 10 amps maximum load.

OUTPUT VOLTAGE REGULATION (for constant line voltage)

DC REGULATED HIGH VOLTAGE: Less than 50 millivolts change no-load to full-load at any output voltage.
 DC REGULATED FIXED BIAS: Less than 50 millivolts change no-load to full-load.
 DC VARIABLE BIAS: Is tied to fixed bias, hence source regulation is same as for fixed bias. Internal impedance 0 to 10,000 ohms, depending on bias control setting.

LINE VOLTAGE REGULATION

Regulated DC output voltages vary less than ± 100 millivolts for line voltage variations 115 volts $\pm 10\%$.

RIPPLE

Less than 500 microvolts.

INTERNAL IMPEDANCE

DC REGULATED HIGH VOLTAGE: (For frequencies above 20 cps.) Full-load: 0.1 ohm in series with 25 microhenries maximum. No-load: 1 ohm in series with 50 microhenries maximum.

RECOVERY TIME

Upon application of full-load: 0.1 millisecond maximum. Upon decrease from full-load to:
 (a) 0 ma, 0.5 millisecond maximum.
 (b) 25 ma, 0.1 millisecond maximum.
 Maximum transient voltage, 1 volt.

METERING

CURRENT METER: 0 to 200 ma. (high voltage only.)
 VOLTMETER: Three ranges, 0 to +500 volts, 0 to +150 volts and 0 to -150 volts. Panel switch connects meter to DC regulated high voltage or DC variable bias and selects range.

TERMINALS

Either positive or negative DC regulated high voltage terminal may be grounded. Positive terminals of both bias supplies and negative terminals of DC regulated high voltage are common.

OVERLOAD PROTECTION

AC line, DC regulated high voltage, DC regulated fixed bias and filament supply are separately fused. DC regulated high voltage drops to a safe value if bias fuse blows.

POWER SUPPLY

115 volts $\pm 10\%$, 50 to 60 cps. Approximately 120 to 450 watts depending on load and line voltage.

DIMENSIONS

Cabinet Mount: 12-3/4" high, 20-3/4" wide, 14-3/4" deep.
 Rack Mount: Panel 10-1/2" high, 19" wide, 13-1/4" deep behind panel.

WEIGHT

Cabinet Mount: 70 lbs. shipping weight approx. 91 lbs.
 Rack Mount: 62 lbs. shipping weight approx. 85 lbs.

TABLE OF CONTENTS
FOR
MODEL 712B POWER SUPPLY

<u>Para.</u>	<u>Page</u>	<u>Para.</u>	<u>Page</u>
SECTION I GENERAL DESCRIPTION		SECTION IV MAINTENANCE	
1-1	General	1-1	
1-2	Inspection	1-1	
SECTION II		4-1	Cover and Bottom Plate Removal 4-1
2-1	Controls and Terminals	2-1	
2-2	Operation	2-2	
SECTION III		4-2	Replacements 4-1
3-1	General	3-1	
3-2	High Voltage Regulator Circuit	3-1	
3-3	Bias Supply Circuit	3-3	
		4-3	Adjustments 4-3
		4-4	Line Regulation Adjustment 4-3
		4-5	Adjustment of Fixed -300 Volt Bias Supply Output Voltage 4-5
		4-6	Adjustment Of HV Supply Output Voltage 4-5
		4-7	Setting Variable Resistor R39 4-5
		4-8	Setting the Stop on the HV Control 4-7

SECTION V
TABLE OF REPLACEABLE PARTS

SECTION I
GENERAL DESCRIPTION

CAUTION

Voltages which are dangerous to life are present at the terminals and within this instrument.

CAUTION

The AC power should be turned on for at least 30 seconds before switching on the high voltage. This allows the regulator circuits to reach their proper operating point and avoids excessive voltage at the high voltage terminals.

1-1 GENERAL

The Model 712B Power Supply is a very stable source of continuously variable direct current for plate and bias circuits. It also provides up to 10 amperes, 6.3 volts alternating current for filament circuits. A two-range voltmeter and a milliammeter (high voltage only) are provided to measure the direct current output. This power supply is very useful as a power source for small transmitters, oscillators, complex systems, certain types of klystrons, and general laboratory use.

1-2 INSPECTION

This instrument was thoroughly tested and inspected before being shipped and is ready for use when received.

After the instrument is unpacked, it should be inspected for damage received in transit. If any shipping damage is found, follow the procedure outlined in the "Claim for Damage in Shipment" page at the back of this instruction manual.

SECTION II
OPERATING INSTRUCTIONS

2-1 CONTROLS AND TERMINALS

AC POWER

This toggle switch controls the power supplied to the instrument from the power line. When the switch is in the ON position the red indicator lamp above the switch will glow.

LINE 4 AMP

The fuseholder, located on the control panel, contains a 4 ampere cartridge fuse for the protection of the whole instrument. The fuse may be replaced by turning the fuseholder cap, removing the old fuse, and inserting a new fuse. Replacement fuses for this instrument must be of the "Slo-Blo" type as specified in the Replaceable Parts List.

-300V 1/16 AMP

The fuseholder, located on the control panel, contains a 1/16 ampere cartridge fuse for the protection of the -300 volt fixed bias supply. The fuse may be replaced by turning the fuseholder cap, removing the old fuse, and inserting a new fuse.

NOTE

If this fuse blows, the positive high-voltage regulator circuit will drop the HV voltage level to less than 100 volts, thus protecting external equipment or circuits against the possibility of damage due to loss of bias. When the open fuse is replaced, all circuits restore to normal.

+HV 1/2 AMP

The fuseholder, located on the control panel, contains a .5 ampere cartridge fuse for the protection of the high voltage dc circuit. The fuse may be replaced by turning the fuseholder cap, removing the old fuse, and inserting a new fuse.

CAUTION

If this fuse blows, immediately turn off the AC POWER switch, and then replace the fuse. Continued operation of the instrument with the +HV 1/2 AMP fuse open will damage the screen grids of the series regulator tubes (V3, V4, V5, V6).

HIGH VOLTAGE

This toggle switch turns the high voltage direct current off and on. The switch also controls the red indicator light above it on the control panel. When the switch is on, the indicator lamp glows as a warning that the high voltage is turned on.

6.3V AC, 10 AMP

The two fuseholders, located on the control panel, each contain a 15 ampere cartridge fuse for protection of the 6.3 volt AC filament supply circuit. Each fuse may be replaced by turning its fuseholder cap, removing the old fuse, and inserting a new fuse. Replacement fuses must be of the "Slo-Blo" type as specified in the Replaceable Parts List.

6.3V AC 10 AMP CT

These binding posts are terminals for the unregulated AC filament supply.

6.3V AC 10 AMP

These are the terminals for the 6.3 volt unregulated alternating current.

CT

This binding post is the terminal for the center tap of the secondary winding from which the unregulated AC is taken.

-300V 50 MA 5 MA GND

These binding posts are terminals for the bias supply output and chassis ground.

-300V 50 MA

Output terminal for the fixed -300V regulated voltage supply.

5 MA
Output terminal for the variable (0-150 volt) regulated bias voltage supply.

GND
Terminal for making connection to the chassis. Any one of the output terminals may be connected to the chassis by connection to terminal GND.

COM +HV GND
These binding posts are terminals for the high voltage supply, common conductor, and chassis ground.

+HV
Output terminal for the regulated 0-500 volt voltage supply.

COM
Output terminal common to the HV, 5 MA (variable bias), and -300V 50 MA (fixed bias) circuits.

GND
Terminal for making connection to the chassis.

-BIAS CONTROL
This control varies the output of the regulated bias voltage supply from 0 to 150 volts.

HV CONTROL
This control varies the output of the regulated high voltage supply from 0 to 500 volts.

METER RANGE
This switch connects the regulated high voltage supply circuit to the voltmeter on either the 0-150V or 0-500V range. Operation of the switch to 0-150 -BIAS connects the variable bias supply circuit to the voltmeter.

2-2 OPERATION

CAUTION

Avoid electric shock by turning the high voltage switch to the off position before making any connections to the instrument.

The procedure for operating the Model 712B Power Supply is as follows:

- a. Connect the power cable to a 115V power line and turn the AC POWER switch to ON.

NOTE

The triple-conductor power cable is supplied with the new NEMA approved three-prong plug. The third conductor provides a chassis ground. An adapter may be obtained to permit use of this plug with two-conductor receptacles.

- b. With the HIGH VOLTAGE switch in the off position, connect the output terminals to the load.
- c. If the bias supply is to be used, set the METER RANGE switch to the 0-150V -BIAS position and adjust the -BIAS CONTROL for the desired voltage.

NOTE

The internal impedance of the variable bias circuit can be as high as 10,000 ohms, depending on the setting of -BIAS CONTROL.

- d. Set the METER RANGE switch at the 0-150V or 500V position, and adjust the HV CONTROL for the desired output voltage.
- e. Turn the HIGH VOLTAGE switch to ON, check the bias voltage, and readjust -BIAS CONTROL if necessary.
- f. If the Model 712B is to be used for an application which requires a power supply of more than 500 volts, up to 300 volts additional may be made available by connecting the load across +HV and -300V 50 MA. Ground may be connected to either terminal, as desired.

3-1 GENERAL

The Model 712B Power Supply furnishes two separate regulated supplies: a positive high voltage in the 0-500 volt range and a bias voltage. A block diagram of the Model 712B is shown in Figure 1.

Voltage level of the high voltage supply is adjusted by means of a panel knob, HV CONTROL, which controls the setting of variable autotransformer T1. The autotransformer supplies primary voltage to the high voltage power transformer, T2. The comparison voltage in the regulator circuit is adjusted by means of variable resistor R39 which is mechanically coupled to the autotransformer shaft. This arrangement maintains the regulator circuit at its optimum operating point, regardless of output voltage level.

After the high voltage has been rectified (dual diodes V1 and V2) and filtered, it is applied to a group of series regulator tubes (pentodes V3-V6), to the DC milliammeter, and then to the high voltage output terminal, +HV. The conduction of the series regulator tubes is controlled by a cascade differential amplifier (dual triodes V12 and V13). The differential amplifier compares a sample of the output voltage with the voltage developed across voltage reference tube V11; any difference between these voltages is amplified and the conductivity of the series regulator tubes is changed accordingly.

The fixed bias voltage (-300V) supply consists of a conventional power transformer, full-wave rectifier (dual diode V7), and capacitor-input filter. The voltage is regulated by means of a series regulator tube (pentode V8), which is controlled in turn by a cascade differential amplifier (dual triodes V9 and V10). Operation of the regulator circuit is similar to the +HV regulator described above.

A source of variable bias voltage is provided by means of a voltage divider (variable resistor R46) which is connected between the -300V 50 MA terminal and the COM terminal. This voltage is regulated against line voltage variations only. Since the internal impedance

may be as high as 10,000 ohms, depending upon the setting of resistor R46, the voltage will depend upon the actual load current being drawn (5 ma. max.). This voltage can be measured by turning the METER RANGE switch to the -150V -BIAS position.

3-2 HIGH VOLTAGE REGULATOR CIRCUIT

The regulator circuit is so arranged that a slight voltage change in the sampled output in the positive direction will result in a relatively large voltage swing in the negative direction on the grids of the series regulator tubes, and vice versa.

Figure 2 shows the arrangement of dual triodes V13 and V12 which, connected in cascade, form a two stage differential amplifier. In each tube, cathode connections are common for the two sections. Thus any variation in plate current in one section appears across the cathode resistor common to both sections, and results in a difference voltage in each of the output circuits.

In the first stage, a fixed bias supplied by voltage reference tube V11 is applied to one grid of dual triode V13. The bias on the other grid of V13 is a portion of the +HV voltage, sampled with respect to the -300 volt bias supply through a voltage divider. Any variation in the level of the output voltage results in voltage changes in the plate circuits of both sections of V13, and corresponding changes in the biases on the grids of dual triode V12 in the next stage.

For example, if the voltage of the sampled output swings in the positive direction, increased current will flow through the right-hand section of V13, which will raise the cathode voltage and lower the right-hand plate (pin 1) voltage. Since the bias on the grid in the left-hand section of V13 remains fixed, the increased cathode voltage will decrease conduction in the left-hand half of the tube, which result in an increase in voltage on the left-hand plate (pin 6).

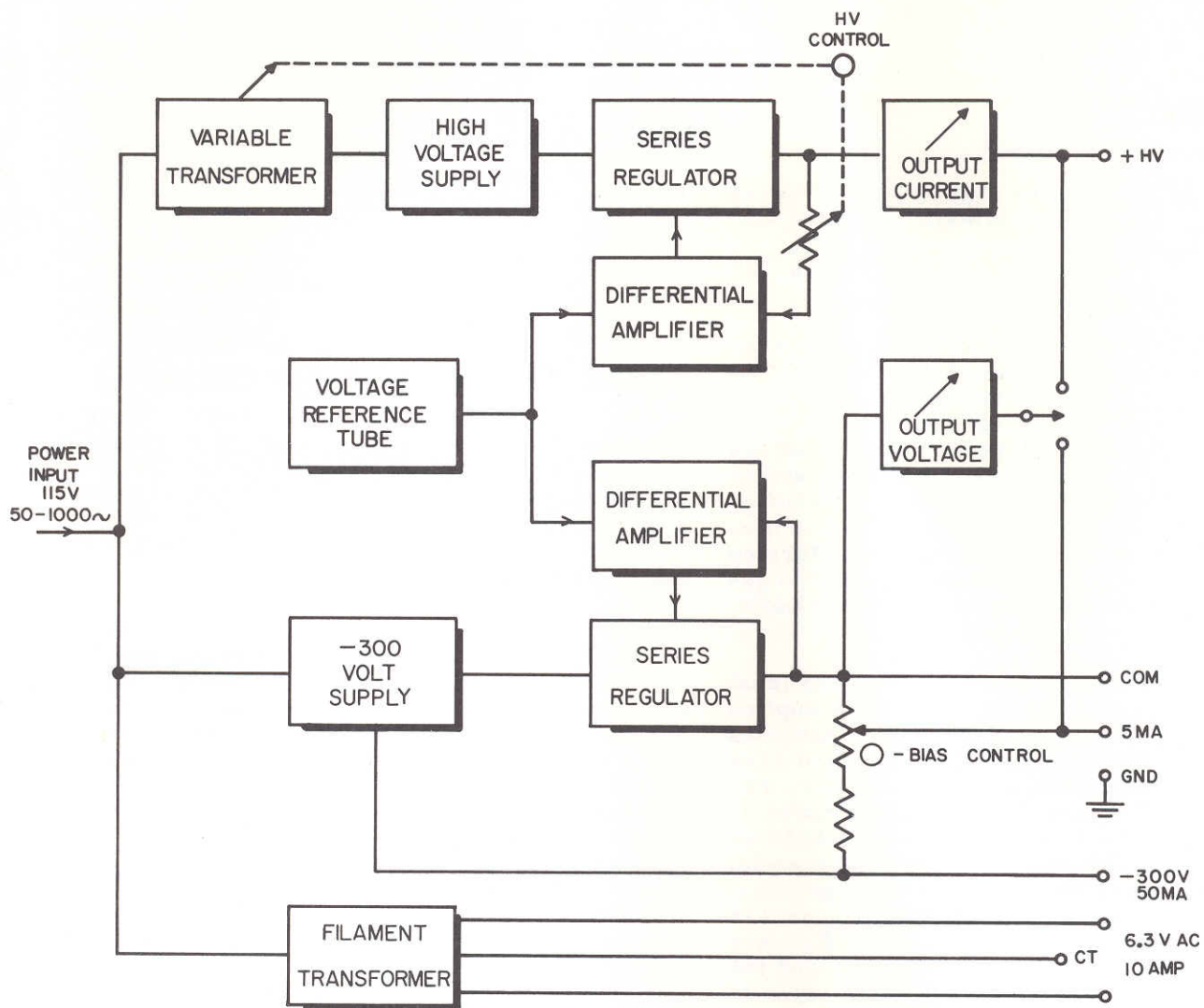

Figure 1. Model 712B Block Diagram

In the second stage, the right-hand section of dual triode VI2 acts as a cathode follower to increase the signal on the grid of the left-hand section. The plate circuit in the left-hand section supplies the bias for the grids of the series regulator tubes. The plate circuits of the two sections of VI2 are cross-coupled. This arrangement results in greater amplifier gain and sensitivity.

To ensure that the series regulator tubes will have sufficient conductivity to maintain regulation under transient conditions, a separate screen voltage supply from selenium rectifier SR1 is provided for the regulator tubes.

The voltage divider in the voltage comparison circuit provides separate paths to the signal grid of dual triode V13 for high-frequency and low-frequency voltages, to make the response of the regulated supply fast at high frequencies and yet very stable. At about 1,000 cycles, AC components are coupled to the grid via resistor R38 and capacitor C4. DC components pass to the grid through a resistor network (R38, R39, R40, R41).

3-3 BIAS SUPPLY CIRCUIT

Arrangement and operation of the regulated bias supply circuit is similar to that of the plate voltage supply circuit except that primary current to the bias supply transformer, T3, is not variable. The bias supply series regulator tube, V8, is controlled by a differential amplifier (dual triodes V10 and V9). The comparison voltage for the circuit is furnished by voltage reference tube V11, and the sample voltage is sampled with respect to COM through a voltage divider which includes variable resistor R24. The fixed bias voltage is brought out to binding post -300V 50 MA on the control panel.

A variable bias voltage is available at binding post 5 MA. The voltage level of the variable bias supply may be adjusted by means of the -BIAS CONTROL knob on the front panel. The control varies the setting of variable resistor R46 in the voltage divider across the bias supply output circuit.

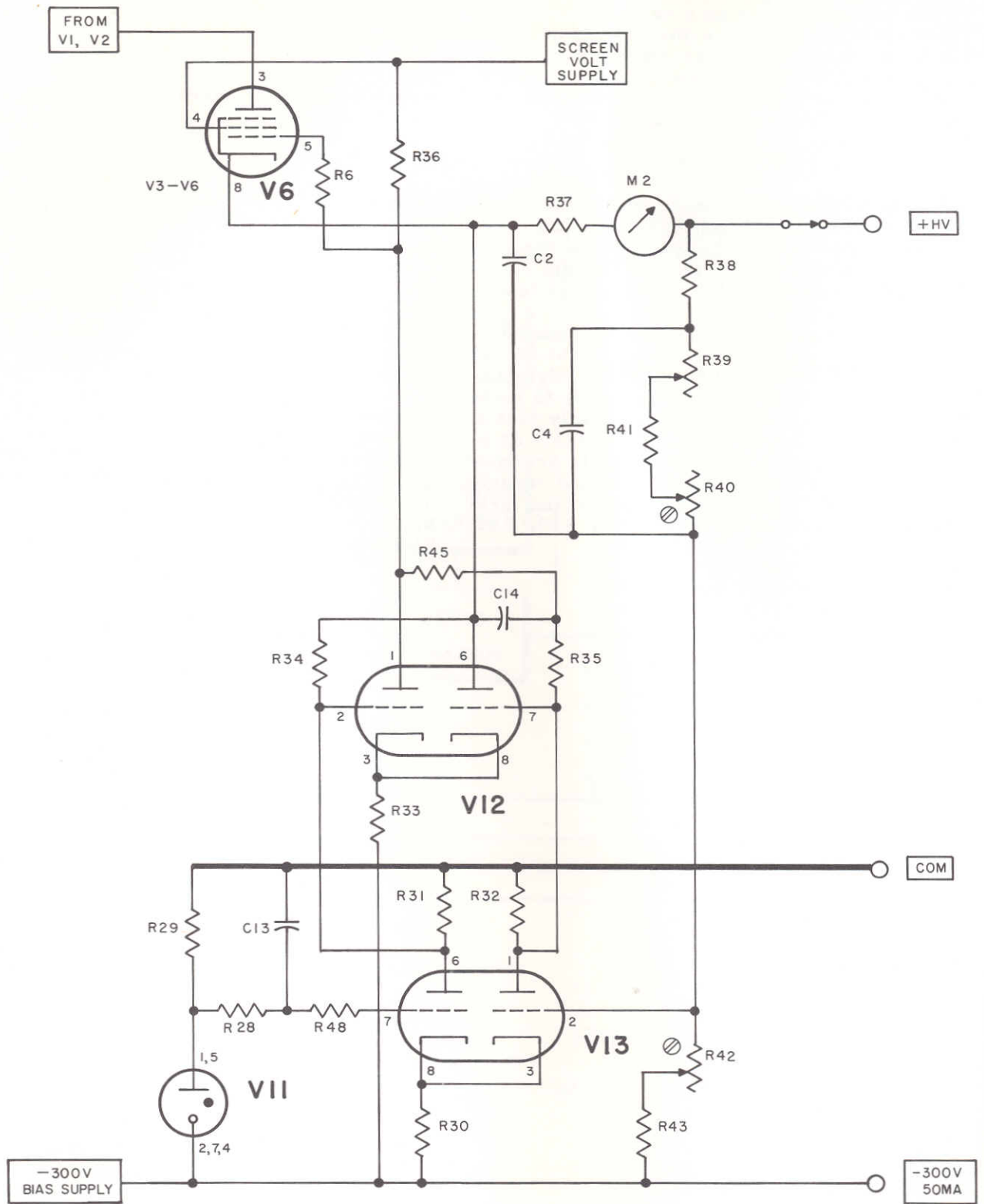

Figure 2. Partial Schematic of High Voltage Supply Regulator Circuit

CAUTION

Voltages which are dangerous to life are present within the instrument. Disconnect the power cable from the power line before removing the cover or bottom plate.

4-1 COVER AND BOTTOM PLATE REMOVAL

Rack Model

To remove the cover, unscrew the four screws which fasten the cover to the back of the instrument, and slide the cover toward the rear of the instrument. To remove the bottom plate, unscrew the four screws which fasten the plate to the bottom of the instrument, and lift off the plate.

Cabinet Model

- a. On the rear of the instrument, remove the four screws which fasten the rear cover to the chassis. Remove the rear cover.
- b. Turn the instrument on its back.
- c. Remove the two 3/16 inch Allen setscrews on the bottom, next to the control panel.
- d. Lift the cabinet off the instrument.

4-2 REPLACEMENTS

Variable Transformer Brush

Inspect the brush contact at periodic intervals. If the brush contact on transformer T1 begins to show excessive wear, purchase a new brush assembly, for a Type 20 variable transformer, from the Superior Electric Co., Bristol, Conn. The brush contact is made of special material and ordinary carbon will not function. Fit the brush to the commutator by sanding with fine crocus cloth. Carbon particles must be blown off the commutator after fitting the brush.

Tubes

Any tube in the Model 712B may be replaced with a tube having corresponding RETMA standard characteristics.

All tubes are accessible when the cover plate or cabinet is removed. Location of tubes is shown in Figure 3.

Tubes V3, V4, V5, or V6 may be replaced with a 6L6, 6L6-G, 6L6-GB or 5881.

Replacement of tube V11 may make it necessary to readjust the output voltage of the fixed, -300 volt bias supply (see Adjustments, paragraph 4-3).

Replacement of tube V10 may make it necessary to readjust the bias supply line regulation (see Adjustments, paragraph 4-3).

Replacement of tube V13 may make it necessary to readjust the HV supply line regulation (see Adjustments, paragraph 4-3).

If ripple is present in the regulated voltage after replacement of tube V9, V10, V12, or V13, probably it is due to excessive heater-cathode leakage in the replacement tube.

Variable Resistors

Connections to all variable resistors are shown in Figure 5.

Resistor R39 is ganged on the shaft with variable transformer T1. Its location, behind the control panel, is shown in Figure 3. The procedure to be followed after a replacement of variable resistor R39 is described under Adjustments, paragraph 4-3. The location of resistor R46, which is adjusted by the -BIAS CONTROL knob, also is shown in Figure 3.

Location of resistors R40, R42, R24, R10, and R8 on the bottom of the instrument are shown in Figure 4.

If resistor R24 is replaced, readjust the level of the fixed -300 volt bias supply (see Adjustments, paragraph 4-3).

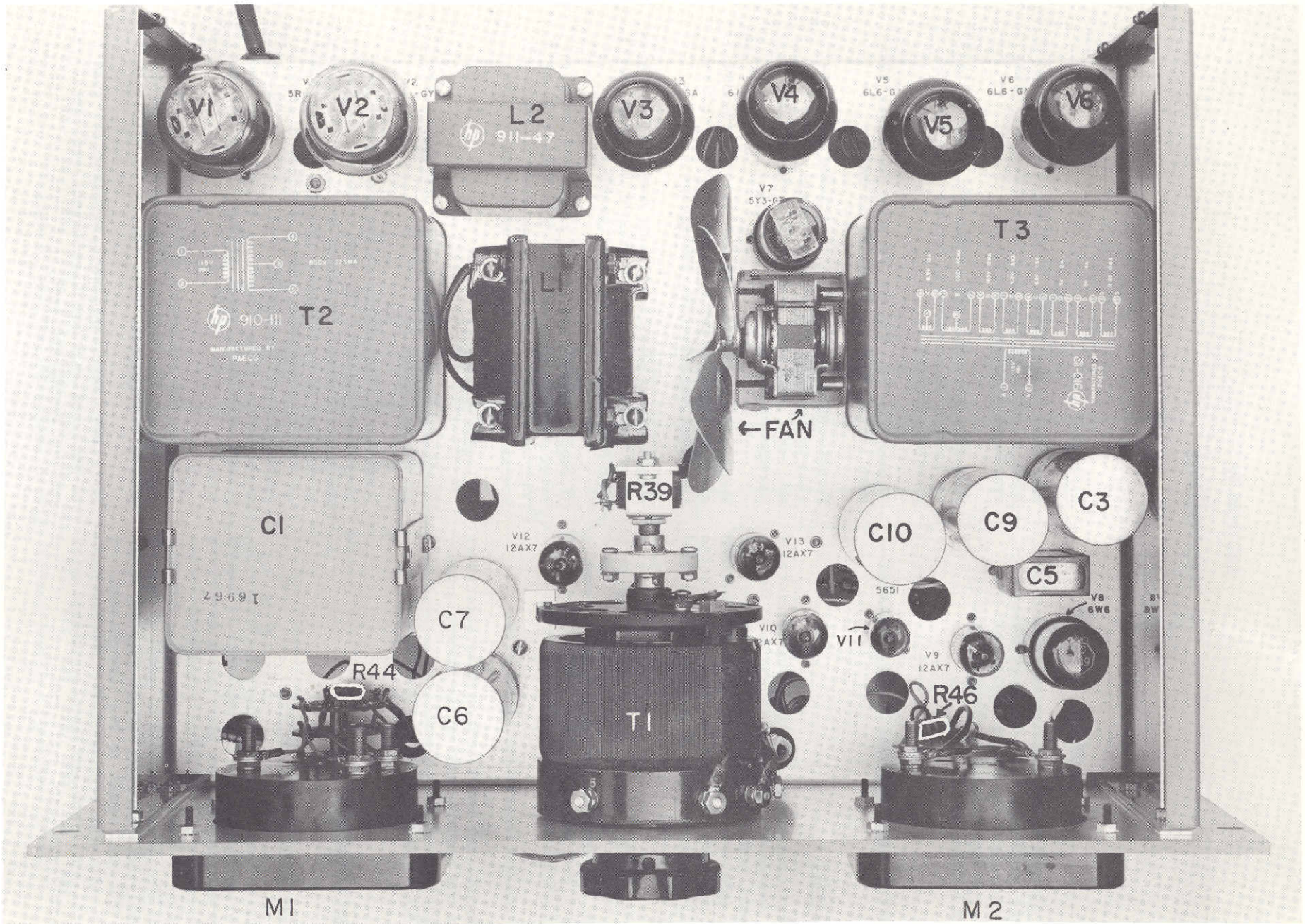

Figure 3. Model 712B Top View Cover Plate Removed

If resistor R42 or resistor R40 is replaced, readjust the maximum and minimum levels of the HV supply output voltage (see Adjustments, paragraph 4-3).

If resistor R8 is replaced, readjust the bias supply line regulation, and if resistor R10 is replaced, readjust the HV supply line regulation (see Adjustments, paragraph 4-3).

Lamps

If either the AC POWER or HIGH VOLTAGE lamp should burn out, replace with the 6-volt lamp specified in the Replaceable Parts List. The lamps are of the bayonet type and are plugged into sockets accessible from the front of the control panel. To remove a burned out lamp:

- a. Turning in a counterclockwise direction, unscrew the lamp cap and remove it.
- b. Firmly press the light bulb into the socket, and then give the bulb a twist in the counterclockwise direction to free it. Pick the bulb out of the socket.

4-3 ADJUSTMENTS

Auxiliary Equipment Required

- | | |
|--|--|
| 1 - variable transformer |) Hewlett-Packard
Model 410B or
equal. |
| 1 - AC voltmeter 0-150 volts | |
| 1 - DC voltmeter 1000 volt range | |
| 1 - High impedance vacuum tube voltmeter | |
| 1 - 300 volt battery | |

NOTE

The settings of variable resistor R39 and the HV CONTROL stop are set at the factory, and should never be touched in the field unless transformer T1 or R39 should require replacement. Adjustment procedures to be performed in the event of the replacement of either component are given at the end of this Adjustments paragraph. If either T1 or R39 is replaced, its respective adjustment procedure should be performed before making the line regulation or output voltage adjustments.

4-4 LINE REGULATION ADJUSTMENT

To adjust the Model 712B line regulation, it is necessary to have (1) a stable source of DC voltage for comparison purposes, (2) a variable transformer, and (3) a sensitive voltmeter (1.0 volt full scale) with an input resistance of 1 megohm or greater (Model 410B). A convenient test set-up for measuring line regulation is illustrated below. Connections shown at the Model 712B are those used when measuring and adjusting the HV supply line regulation.

Adjustment of Bias Supply Line Regulation

- a. Make connections as shown in the test set-up below, except that the positive side of the battery is to be connected to the COM terminal on the Model 712B control panel and the negative terminal of the VTVM is to be connected to the -300V 50 MA terminal.

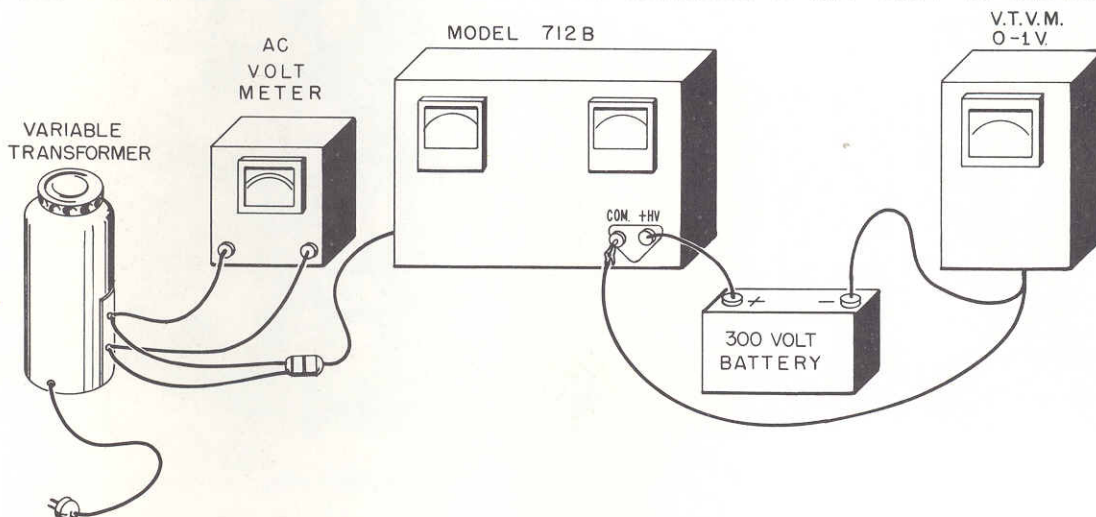

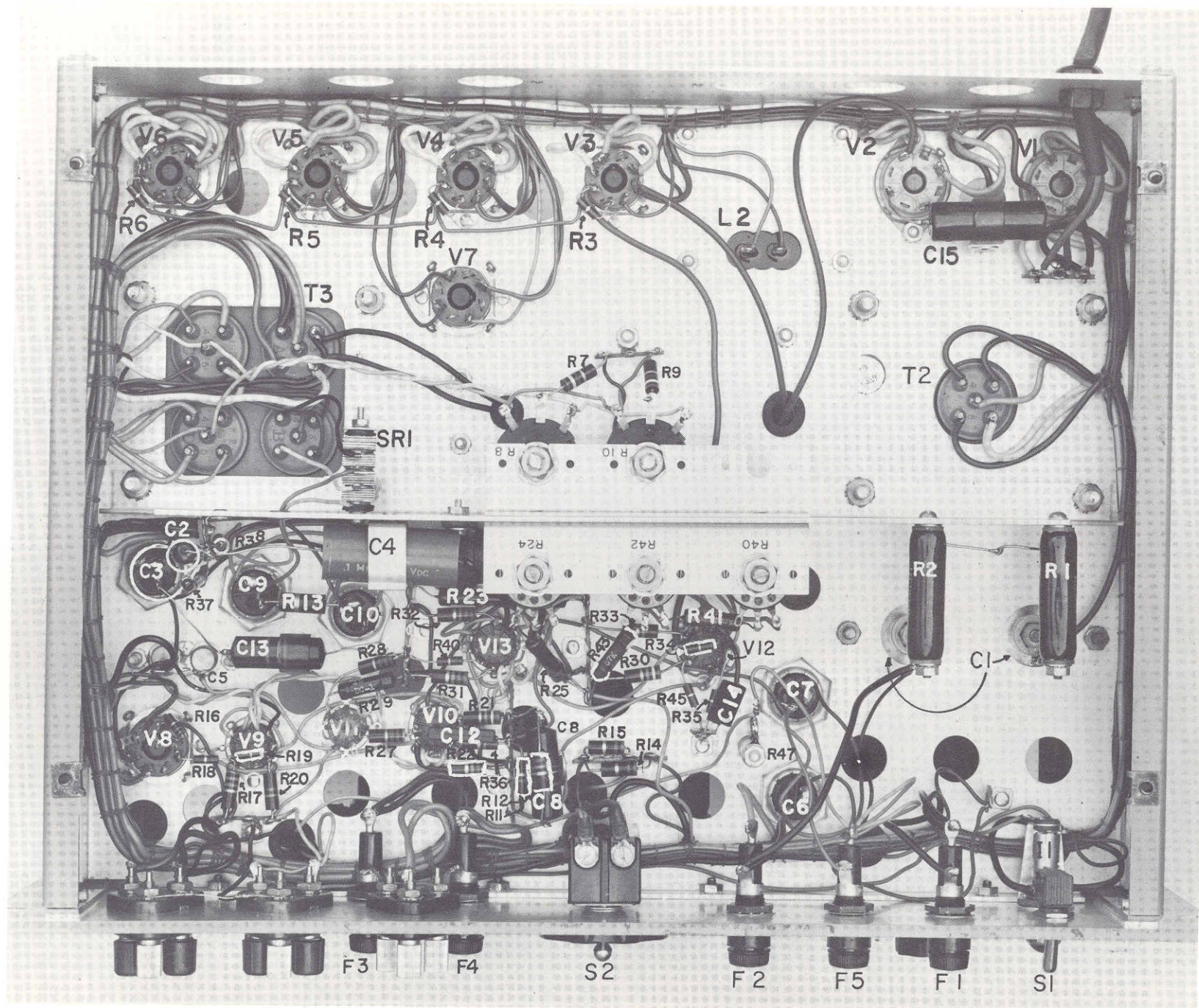

Figure 4. Model 712B Bottom View Bottom Plate Removed

b. Set the variable transformer to 103 volts and allow about 15 seconds for the circuit to stabilize. Note the reading of the VTVM.

c. Change the variable setting to 128 volts. After about 5 seconds the VTVM will indicate a temporary slow drift in the -300 volt supply voltage. When the circuit again stabilizes, note the new reading of the VTVM.

d. If the new reading of the VTVM differs by more than .01 - .02 volt, adjust variable resistor R8 (see Figure 4), and repeat steps b and c.

f. Repeat steps b - d until the circuit stabilizes to within .01 - .02 volt for line voltage changes of 103-128 volts.

Adjustment of HV Supply Line Regulation

a. Make connections as shown on the suggested test set-up below.

b. The procedure is the same as for measuring and adjusting the bias supply line regulation except that variable resistor R10 is adjusted to stabilize the HV supply circuit.

4-5 ADJUSTMENT OF FIXED -300 VOLT BIAS SUPPLY OUTPUT VOLTAGE

a. Check that the Model 712B power cable is disconnected from the power source. Remove the cover and bottom plates. Place the instrument on its back so that both the front panel and the under side of the instrument will be accessible.

b. Attach a DC voltmeter (Model 410B) between the COM and -300V 50 MA terminals on the control panel.

c. Connect a variable transformer between the power source and the Model 712B power cable. Turn the AC POWER switch to ON, and allow the instrument to warm up for about one minute. Adjust the variable transformer so that 115 volts is applied to the Model 712B.

d. Adjust variable resistor R24 until the test voltmeter reads -300 volts.

4-6 ADJUSTMENT OF HV SUPPLY OUTPUT VOLTAGE

a. Set up the instrument as in steps a and c of the previous adjustment procedure.

b. With the METER RANGE switch in the 0-500V position and the HV CONTROL in its maximum clockwise position, adjust variable resistor R42 (see Figure 4) until the DC voltmeter on the control panel reads +500.

c. Rotate the HV CONTROL to its maximum counterclockwise position (minimum output) and switch the METER RANGE switch to the 0-150V position. Adjust variable resistor R40 until the DC voltmeter reads 0 volts.

d. Since the settings of R40 and R42 are interdependent, it may be necessary to repeat steps b and c several times.

NOTE

The indicated meter zero could be off a volt or so due to change in meter position when instrument is on its back.

4-7 SETTING VARIABLE RESISTOR R39

This adjustment is to be made only if variable resistor R39 or transformer T1 has been replaced. Resistor R39 is mechanically coupled to the shaft of the variable transformer T1. The assembly is located behind the control panel (see Figure 3) above the deck, and is accessible when the cover plate is removed.

a. Check that the power cable is disconnected down from the power source.

b. With an Allen wrench loosen the two set screws which secure the coupling to the transformer shaft. (Do not loosen the set screws which secure the coupling to the resistor shaft.)

c. Set the HV CONTROL to its maximum counterclockwise position. Set the METER RANGE switch to the 0-150V -BIAS position.

d. Connect an ohmmeter across the R39 lead.

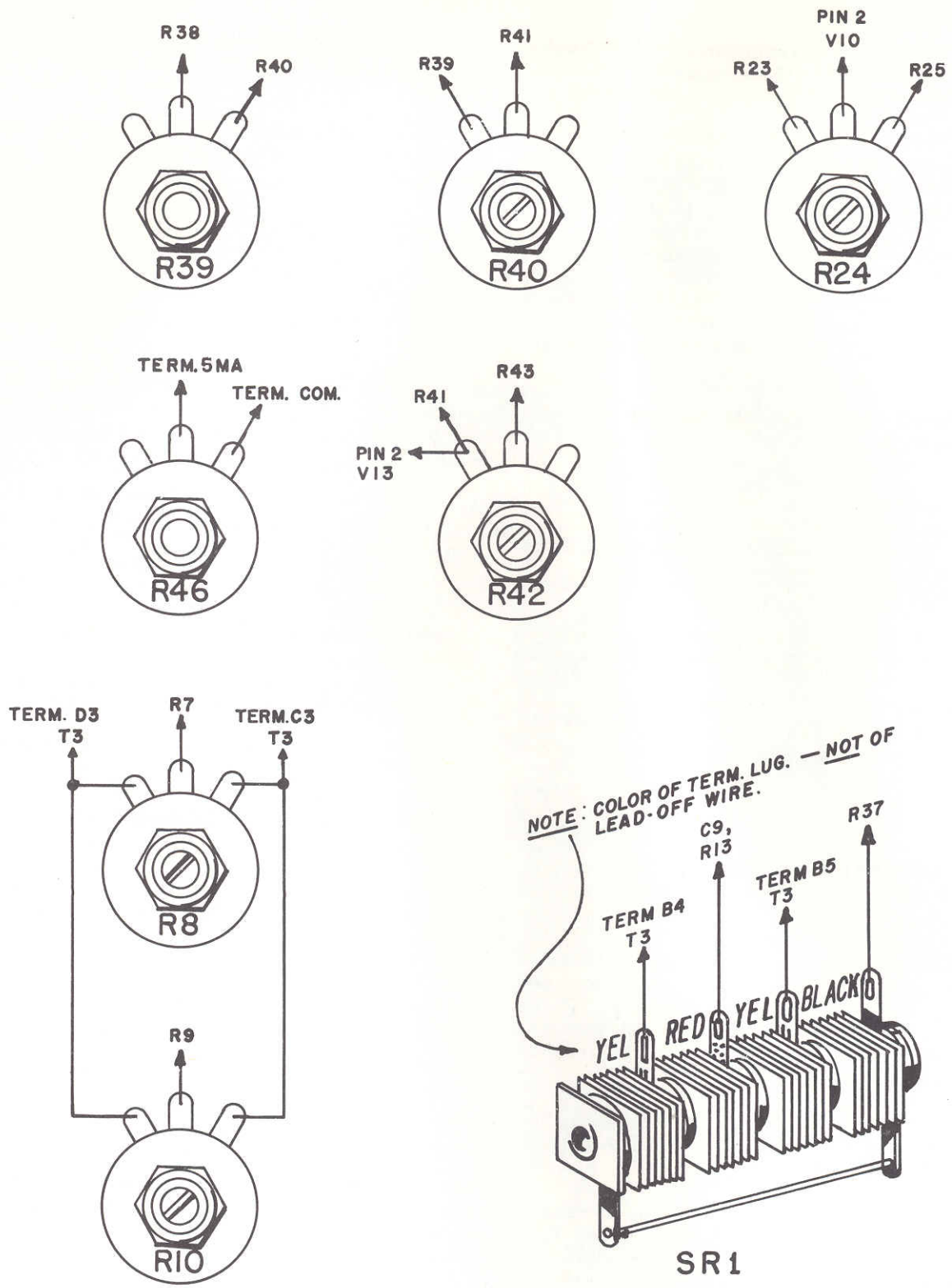

Figure 5. Model 712B Detail of Variable Resistors and Selenium Rectifier

- e. By means of the coupling, adjust the position of the resistor shaft until an ohmmeter reading of 25K ohms is obtained.
- f. Hold the shaft in this position, and tighten the setscrews which secure the coupling to the transformer shaft. Remove the ohmmeter.
- g. Check and if necessary readjust the level of the HV output as described in Adjustment of HV Supply Output Voltage, paragraph 4-6.

4-8 SETTING THE STOP ON THE HV CONTROL

This adjustment is to be made only if variable transformer T1 has been replaced. The movable stop is a small "C" clamp which is attached to the wiper ring on the back of the variable transformer.

- a. Check that the power cable is disconnected from the power source.
- b. Use an Allen wrench to loosen the setscrew which secures the stop to the rim of the transformer wiper ring, and remove the stop.

- c. Attach a DC voltmeter (Model 410B, 1,000 volt range) between terminal COM on the control panel and socket pin 3 of tube V3.
- d. Plug the Model 712B power cable into a variable transformer set for 115 volts (measured).
- e. Turn off the HIGH VOLTAGE switch. Set the METER RANGE switch at 0-500V and the HV CONTROL to its maximum counterclockwise position. Turn the AC POWER switch to ON, and allow at least a 30-second warm-up.
- f. Advance the HV CONTROL in a clockwise direction until the test voltmeter reads +380 volts.
- g. Turn off the AC POWER switch, disconnect the Model 712B power cable and attach the stop to the transformer wiper ring so that the movable stop rests against the stationary stop in such a manner that the HV CONTROL cannot return in a counterclockwise direction. Note that the stop sets the minimum voltage applied to the series regulator tubes.
- h. Remove the voltmeter.
- i. Check the setting of variable resistor R39, as described above.

TROUBLE SHOOTING CHART

The following information is designed to aid in trouble shooting a defective instrument:

SYMPTOMS	POSSIBLE CAUSE	TEST PROCEDURE	REMEDIES																
Instrument NOT operating, pilot light NOT on.	Line fuse F1 blown due to defective fuse or overload in either power supply.	<p>Replace fuse. If this fuse blows, remove tubes V1, V2, and V7, and again replace fuse F1. If this fuse blows, it indicates:</p> <ol style="list-style-type: none"> 1. Short circuit in wiring associated with power transformer T2 or T3. 2. Short circuit in filament wiring. 3. Transformer T2 or T3 is defective. <p>If fuse does not blow when rectifying tubes are removed, it indicates:</p> <ol style="list-style-type: none"> 1. Defective filter capacitor. 2. Short circuit in a tube. 3. Short circuit in the direct current wiring. <p>To localise the circuit in trouble, measure the DC resistance across the output from each of the three rectifiers. Disconnect the instrument from the power line before making the measurements.</p> <p>Normal DC Resistances Across Power Supply Circuits:</p> <table style="width: 100%; border-collapse: collapse;"> <tr> <td style="width: 10%;"></td> <td style="width: 40%;">Rectifier</td> <td style="width: 30%;">Connect Ohm-meter Across</td> <td style="width: 20%;">Approx. Normal Resist. (Ohms)</td> </tr> <tr> <td>V1, V2</td> <td>Socket pin 8, V1 or V2, and term. COM</td> <td></td> <td style="text-align: center;">50K</td> </tr> <tr> <td>V7</td> <td>Socket pin 8 V7, and term. -300V 50 MA</td> <td></td> <td style="text-align: center;">2M</td> </tr> <tr> <td>SR1</td> <td>Terms. of capacitor C9 (connect meter neg. lead to junction of C9 and R13)</td> <td></td> <td style="text-align: center;">1.5M</td> </tr> </table>		Rectifier	Connect Ohm-meter Across	Approx. Normal Resist. (Ohms)	V1, V2	Socket pin 8, V1 or V2, and term. COM		50K	V7	Socket pin 8 V7, and term. -300V 50 MA		2M	SR1	Terms. of capacitor C9 (connect meter neg. lead to junction of C9 and R13)		1.5M	<ol style="list-style-type: none"> 1. Locate and clear short circuit. 2. Locate and clear short circuit. 3. Replace defective transformer. 1. Locate and replace defective capacitor. 2. Locate and replace defective tube. 3. Locate and clear short circuit.
	Rectifier	Connect Ohm-meter Across	Approx. Normal Resist. (Ohms)																
V1, V2	Socket pin 8, V1 or V2, and term. COM		50K																
V7	Socket pin 8 V7, and term. -300V 50 MA		2M																
SR1	Terms. of capacitor C9 (connect meter neg. lead to junction of C9 and R13)		1.5M																
Instrument NOT operating, pilot light ON.	Defective tube or component causing improper operation.	<p>Set METER RANGE switch at 0-150V -BIAS and turn -BIAS CONTROL to its maximum clockwise position. If voltmeter on control panel does not deflect or reads less than 150 volts, trouble is in bias supply circuit. Check bias supply DC voltages against those indicated on schematic diagram (should agree within $\pm 10\%$).</p>	Locate defective component, and replace.																

SYMPTOMS	POSSIBLE CAUSE	TEST PROCEDURE	REMEDIES
		<p>If voltmeter reads -150 volts or more, trouble probably is in HV supply circuit. Set METER RANGE switch at 0-500V and turn HV CONTROL to maximum clockwise position. If voltmeter does not deflect, trouble is in HV supply circuit, and DC voltages should be checked against those shown on the schematic. If voltmeter reads less than 500 volts, trouble may be in either regulator circuit.</p>	<p>Locate defective component, and replace.</p>
<p>Instrument operating, but output voltage deviates from desired level:</p> <p><u>High Voltage Supply</u> Voltage slightly negative</p> <p>Voltage low</p>	<p>Defective fuse, or defective tube (or associated component) in regulator circuit, as detailed below:</p> <p>Fuse F2 (+HV) blown</p> <p>Fuse F5 (-300V) blown V10 V9 V13</p>	<p>Check for open fuse.</p> <ol style="list-style-type: none"> 1. Check for open fuse. 2. Check for burned-out tube. 3. If all tubes are operating, check defective tube in suspected circuit by substituting tube known to be good. 4. Test external components in suspected tube circuit. 	<p>Replace blown fuse.</p> <ol style="list-style-type: none"> 1. Replace blown fuse. 2. Replace burned-out tube. 3. Replace any defective tube. 4. Replace any defective component.
<p>Voltage high</p>	<p>V11 V12 V7 V8</p>	<ol style="list-style-type: none"> 1. Check for burned-out tube. 2. If all tubes are operating, check for defective tube in suspected circuit by substituting tube known to be good. 	<ol style="list-style-type: none"> 1. Replace burned-out tube. 2. Replace any defective tube.
<p><u>-300V Bias Supply</u> Voltage slightly positive</p> <p>Voltage low</p> <p>Voltage high</p>	<p>V8 V7</p> <p>V11</p> <p>V9 V10</p>	<ol style="list-style-type: none"> 3. Test external components in suspected tube circuit. 	<ol style="list-style-type: none"> 3. Replace any defective component.

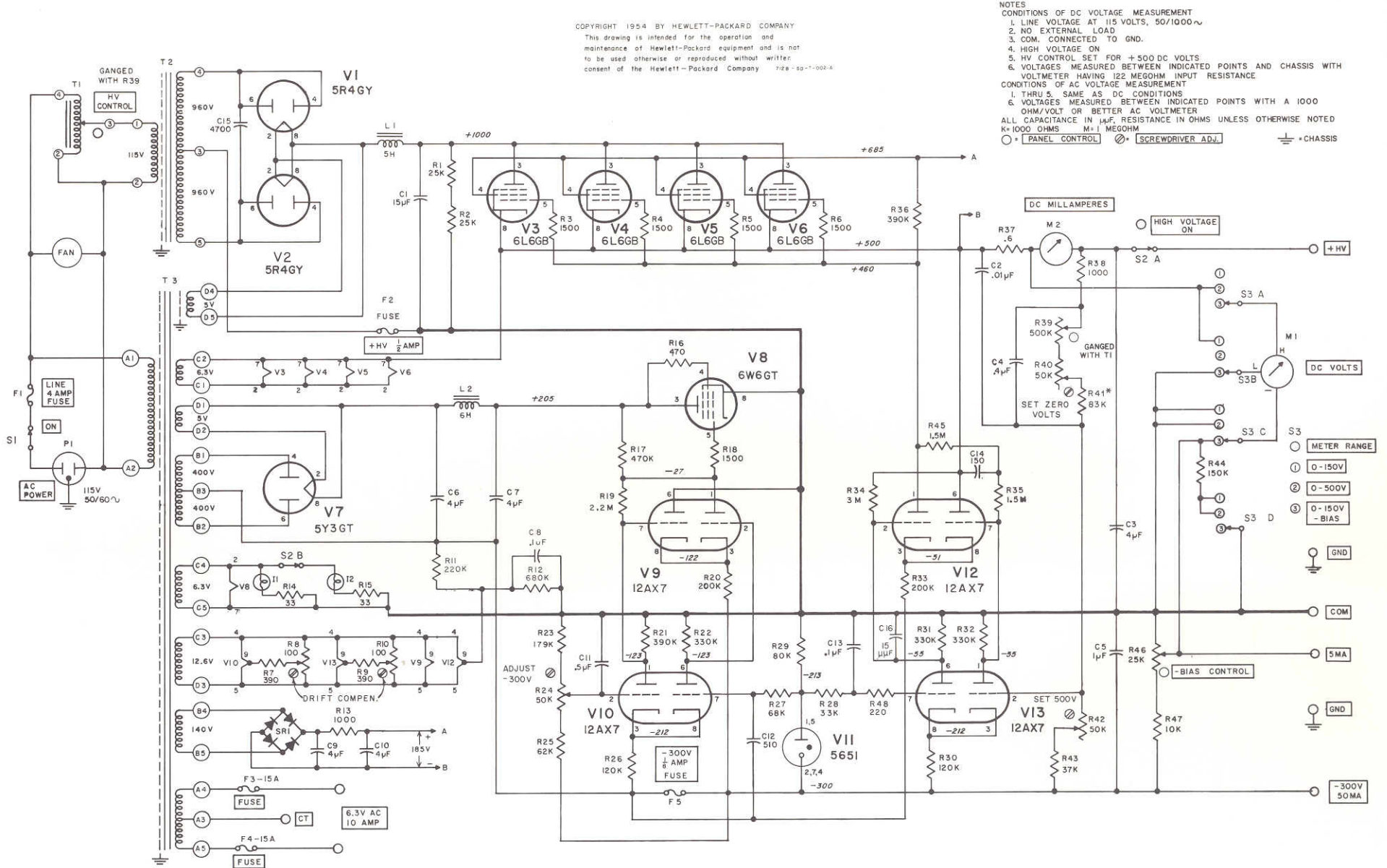

Figure 6. Model 712B Regulated Power Supply

SECTION V

TABLE OF REPLACEABLE PARTS

NOTE

Standard components have been used in this instrument, whenever possible. Special components may be obtained from your local Hewlett-Packard representative or from the factory.

When ordering parts always include:

1.  Stock Number.
2. Complete description of part including circuit reference.
3. Model number and serial number of instrument.
4. If part is not listed, give complete description, function and location of part.

Corrections to the Table of Replaceable Parts are listed on an Instruction Manual Change sheet at the front of this manual.

RECOMMENDED SPARE PARTS LIST

Column RS in the Table lists the recommended spare parts quantities to maintain one instrument for one year of isolated service. Order complete spare parts kits from the Factory Parts Sales Department. ALWAYS MENTION THE MODEL AND SERIAL NUMBERS OF INSTRUMENTS INVOLVED.

TABLE OF REPLACEABLE PARTS

CIRCUIT REF.	DESCRIPTION, MFR. * & MFR. DESIGNATION	STOCK NO.	TQ	RS		
C1	Capacitor: fixed, paper 15 μ f +40% -15%, 1000 vdcw CC*	0160-0096	1	1		
C2	Capacitor: fixed, paper, .01 μ f \pm 10%, 1600 vdcw CC*	0160-0023	1	1		
C3	Capacitor: fixed, paper, 4 μ f \pm 10%, 600 vdcw P*	0160-0077	5	2		
C4	Capacitor: fixed, paper, .4 μ f 1000 vdcw P*	0160-0033	1	1		
C5	Capacitor: fixed, paper, 1 μ f \pm 10%, 600 vdcw Z*	0160-0079	1	1		
C6, 7	Same as C3					
C8	Capacitor: fixed, paper, .1 μ f \pm 10%, 400 vdcw CC*	0160-0013	2	1		
C9, 10	Same as C3					
C11	Capacitor: fixed, paper, .5 μ f \pm 10%, 400 vdcw J*	0160-0024	1	1		
C12	Capacitor: fixed, silver mica 510 pf \pm 5%, 500 vdcw A*	0140-0065	1	1		
C13	Same as C8					
C14	Capacitor: fixed, mica, 150 pf \pm 10%, 500 vdcw V*	0140-0055	1	1		
C15	Capacitor: fixed, paper, 4700 pf \pm 20%, 6000 vdcw CC*	0160-0036	1	1		
C16	Capacitor: fixed, mica, 15 pf \pm 10%, 500 vdcw V*	0140-0004	1	1		
F1	Fuse: Cartridge, 4A, Slow blow type E*	2110-0014	1	10		
F2	Fuse: Cartridge, 1/2 A; 250V T*	2110-0012	1	10		
F3, 4	Fuse: Cartridge, 15 amp, Slow blow type T*	2110-0025	2	20		
F5	Fuse: Cartridge, 1/8 amp T*	2110-0027	1	10		
Il, 2	Lamp, incandescent: 6-8V, 2 pin base, G. E. #12 N*	2140-0012	2	2		
L1	Reactor: 5 H at 225 MA HP*	9110-0018	1	1		
L2	Reactor: 6 H at 125 MA HP*	9110-0017	1	1		
M1	Meter: 0-150V, 0-500V, DC Simpson	1120-0018	1	1		
M2	Meter: 0-200 MA, DC Simpson	1120-0017	1	1		
P1	Power Cable TT*	8120-0015	1	1		

* See "List of Manufacturers Code Letters For Replaceable Parts Table".

TQ -Total quantity used in the instrument.

RS -Recommended spares for one year isolated service for one instrument.

TABLE OF REPLACEABLE PARTS

CIRCUIT REF.	DESCRIPTION, MFR. * & MFR. DESIGNATION	Ⓢ STOCK NO.	TQ	RS		
R1, 2	Resistor: fixed, wirewound, 25,000 ohms ±20%, 20 W S*	0819-0010	2	1		
R3, 4, 5, 6	Resistor: fixed, composition, 1500 ohms ±10%, 1/2 W B*	0687-1521	5	2		
R7	Resistor: fixed, composition, 390 ohms ±10%, 1 W B*	0690-3911	2	1		
R8	Resistor: variable, wirewound, 100 ohms ±10%, 2 W B*	2100-0003	2	1		
R9	Same as R7					
R10	Same as R8					
R11	Resistor: fixed, composition, 220,000 ohms ±10%, 1 W B*	0690-2241	1	1		
R12	Resistor: fixed, composition, 680,000 ohms ±10%, 1 W B*	0690-6841	1	1		
R13	Resistor: fixed, composition, 1000 ohms ±10%, 2 W B*	0693-1021	1	1		
R14, 15	These circuit references not assigned					
R16	Resistor: fixed, composition, 470 ohms ±10%, 1/2 W B*	0687-4711	1	1		
R17	Resistor: fixed, composition, 470,000 ohms ±10%, 1 W B*	0690-4741	1	1		
R18	Same as R3					
R19	Resistor: fixed, composition, 2.2 megohms ±10%, 1/2 W B*	0687-2251	1	1		
R20	Resistor: fixed, composition, 200,000 ohms ±5%, 1 W B*	0689-2045	2	1		
R21	Resistor: fixed, composition, 390,000 ohms ±10%, 1 W B*	0690-3941	2	1		
R22	Resistor: fixed, composition, 330,000 ohms ±10%, 1 W B*	0690-3341	3	1		
R23	Resistor: fixed, deposited carbon, 179,000 ohms ±1%, 2 W NN*	0733-0001	1	1		
R24	Resistor: variable, composition, linear taper, 50,000 ohms -20%, 1/3 W BO*	2100-0157	2	1		
R25	Resistor: fixed, deposited carbon, 62,000 ohms ±1%, 1 W NN*	0730-0055	1	1		
R26	Resistor: fixed, composition, 120,000 ohms ±10%, 1 W B*	0690-1241	2	1		

* See "List of Manufacturers Code Letters For Replaceable Parts Table".

TQ - Total quantity used in the instrument.

RS - Recommended spares for one year isolated service for one instrument.

TABLE OF REPLACEABLE PARTS

CIRCUIT REF.	DESCRIPTION, MFR. * & MFR. DESIGNATION	STOCK NO.	TQ	RS		
R27	Resistor: fixed, composition, 68,000 ohms $\pm 10\%$, 1 W B*	0690-6831	1	1		
R28	Resistor: fixed, composition, 33,000 ohms $\pm 10\%$, 1 W B*	0690-3331	1	1		
R29	Resistor: fixed, deposited carbon, 80,000 ohms $\pm 1\%$, 1 W NN*	0730-0062	1	1		
R30	Same as R26					
R31, 32	Same as R22					
R33	Same as R20					
R34	Resistor: fixed, composition, 3 megohms $\pm 5\%$, 1/2 W B*	0686-3055	1	1		
R35	Resistor: fixed, composition, 1.5 megohms $\pm 5\%$, 1/2 W B*	0686-1555	2	1		
R36	Same as R21					
R37	Resistor: fixed, wirewound, .6 ohms $\pm 10\%$, 2 W HP*	0813-0008	1	1		
R38	Resistor: fixed, composition, 1000 ohms $\pm 10\%$, 1 W B*	0690-1021	1	1		
R39	Resistor: variable, composition, 500,000 ohms $\pm 10\%$ B*	2100-0043	1	1		
R40	Same as R24					
R41	Resistor: fixed, deposited carbon, 83,000 ohms $\pm 1\%$, 1 W Optimum value selected at factory. Average value shown. NN*	0730-0063	1	1		
R42	Resistor: variable, composition, 50,000 ohms $\pm 10\%$ B*	2100-0028	1	1		
R43	Resistor: fixed, deposited carbon, 37,000 ohms $\pm 1\%$, 1 W HP*	0730-0049	1	1		
R44	Resistor: fixed, composition, 150,000 ohms $\pm 10\%$, 1 W B*	0690-1541	1	1		
R45	Same as R35					
R46	Resistor: variable, wirewound, 25,000 ohms $\pm 10\%$, 3 W I*	2100-0008	1	1		
R47	Resistor: fixed, wirewound, 10,000 ohms $\pm 10\%$, 10 W S*	0816-0008	1	1		
R48	Resistor: fixed, composition, 220 ohms $\pm 10\%$, 1/2 W B*	0687-2211	1	1		

* See "List of Manufacturers Code Letters For Replaceable Parts Table".

TQ - Total quantity used in the instrument.

RS - Recommended spares for one year isolated service for one instrument.

TABLE OF REPLACEABLE PARTS

CIRCUIT REF.	DESCRIPTION, MFR. * & MFR. DESIGNATION	hp STOCK NO.	TQ	RS		
S1	Toggle Switch: SPST D*	3101-0001	1	1		
S2	Toggle Switch: DPDT D*	3101-0007	1	1		
S3	Rotary Switch: Assembly, includes R44 HP*	712B-19	1	1		
SR1	Diode, selenium Radio Receptor	1882-0004	1	1		
T1	Variable Transformer HP*	9100-0020	1	1		
T2	Power Transformer HP*	9100-0048	1	1		
T3	Power Transformer HP*	9100-0049	1	1		
V1, 2	Tube electron: 5R4GYA ZZ*	1930-0007	2	2		
V3, 4, 5, 6	Tube electron: 6L6GB (6L6, 6L6G or 5881 may be used) ZZ*	1923-0035	4	4		
V7	Tube electron: 5Y3GT ZZ*	1930-0010	1	1		
V8	Tube electron: 6W6GT ZZ*	1923-0039	1	1		
V9, 10	Tube electron: 12AX7 ZZ*	1932-0030	4	4		
V11	Tube electron: 5651 ZZ*	1940-0001	1	1		
V12, 13	Same as V9					
<u>MISCELLANEOUS</u>						
	Binding post assembly: black HP*	AC-10C	4	1		
	Binding post assembly: red HP*	AC-10D	5	2		
	Flexible coupling HP*	M-25	1	1		
	Fan Motor PP*	3140-0010	1	1		
	Fan Blade Torrington Mfr. Co.	3160-0012	1	1		
	Conversion Kit (conversion of cabinet mount to rack mount) HP*	35F-95A				
	Lampholder, for 2 pin base AD*	1450-0022	2	1		
	Jewel, red HP*	1450-0020	2	1		

* See "List of Manufacturers Code Letters For Replaceable Parts Table".

TQ - Total quantity used in the instrument.

RS - Recommended spares for one year isolated service for one instrument.

LIST OF CODE LETTERS USED IN TABLE OF REPLACEABLE PARTS TO DESIGNATE THE MANUFACTURERS

CODE LETTER	MANUFACTURER	ADDRESS	CODE LETTER	MANUFACTURER	ADDRESS
A	Aerovox Corp.	New Bedford, Mass.	AK	Hammerlund Mfg. Co., Inc.	New York 1, N. Y.
B	Allen-Bradley Co.	Milwaukee 4, Wis.	AL	Industrial Condenser Corp.	Chicago 18, Ill.
C	Amperite Co.	New York, N. Y.	AM	Insuline Corp. of America	Manchester, N. H.
D	Arrow, Hart & Hegeman	Hartford, Conn.	AN	Jennings Radio Mfg. Corp.	San Jose, Calif.
E	Bussman Manufacturing Co.	St. Louis, Mo.	AO	E. F. Johnson Co.	Waseca, Minn.
F	Carborundum Co.	Niagara Falls, N. Y.	AP	Lenz Electric Mfg. Co.	Chicago 47, Ill.
G	Centralab	Milwaukee 1, Wis.	AQ	Micro-Switch	Freeport, Ill.
H	Cinch-Jones Mfg. Co.	Chicago 24, Ill.	AR	Mechanical Industries Prod. Co.	Akron 8, Ohio
HP	Hewlett-Packard Co.	Palo Alto, Calif.	AS	Model Eng. & Mfg., Inc.	Huntington, Ind.
I	Clarostat Mfg. Co.	Dover, N. H.	AT	The Muter Co.	Chicago 5, Ill.
J	Cornell Dubilier Elec. Co.	South Plainfield, N. J.	AU	Ohmite Mfg. Co.	Skokie, Ill.
K	Hi-Q Division of Aerovox	Olean, N. Y.	AV	Resistance Products Co.	Harrisburg, Pa.
L	Erie Resistor Corp.	Erie 6, Pa.	AW	Radio Condenser Co.	Camden 3, N. J.
M	Fed. Telephone & Radio Corp.	Clifton, N. J.	AX	Shallcross Manufacturing Co.	Collingdale, Pa.
N	General Electric Co.	Schenectady 5, N. Y.	AY	Solar Manufacturing Co.	Los Angeles 58, Calif.
O	General Electric Supply Corp.	San Francisco, Calif.	AZ	Sealectro Corp.	New Rochelle, N. Y.
P	Girard-Hopkins	Oakland, Calif.	BA	Spencer Thermostat	Attleboro, Mass.
Q	Industrial Products Co.	Danbury, Conn.	BC	Stevens Manufacturing Co.	Mansfield, Ohio
R	International Resistance Co.	Philadelphia 8, Pa.	BD	Torrington Manufacturing Co.	Van Nuys, Calif.
S	Lectrohm Inc.	Chicago 20, Ill.	BE	Vector Electronic Co.	Los Angeles 65, Calif.
T	Littlefuse Inc.	Des Plaines, Ill.	BF	Weston Electrical Inst. Corp.	Newark 5, N. J.
U	Maguire Industries Inc.	Greenwich, Conn.	BG	Advance Electric & Relay Co.	Burbank, Calif.
V	Micamold Radio Corp.	Brooklyn 37, N. Y.	BH	E. I. DuPont	San Francisco, Calif.
W	Oak Manufacturing Co.	Chicago 10, Ill.	BI	Electronics Tube Corp.	Philadelphia 18, Pa.
X	P. R. Mallory Co., Inc.	Indianapolis, Ind.	BJ	Aircraft Radio Corp.	Boonton, N. J.
Y	Radio Corp. of America	Harrison, N. J.	BK	Allied Control Co., Inc.	New York 21, N. Y.
Z	Sangamo Electric Co.	Marion, Ill.	BL	Augat Brothers, Inc.	Attleboro, Mass.
AA	Sarkes Tarzian	Bloomington, Ind.	BM	Carter Radio Division	Chicago, Ill.
BB	Signal Indicator Co.	Brooklyn 37, N. Y.	BN	CBS Hytron Radio & Electric	Danvers, Mass.
CC	Sprague Electric Co.	North Adams, Mass.	BO	Chicago Telephone Supply	Elkhart, Ind.
DD	Stackpole Carbon Co.	St. Marys, Pa.	BP	Henry L. Crowley Co., Inc.	West Orange, N. J.
EE	Sylvania Electric Products Co.	Warren, Pa.	BQ	Curtiss-Wright Corp.	Carlstadt, N. J.
FF	Western Electric Co.	New York 5, N. Y.	BR	Allen B. DuMont Labs	Clifton, N. J.
GG	Wilkor Products, Inc.	Cleveland, Ohio	BS	Excel Transformer Co.	Oakland, Calif.
HH	Amphenol	Chicago 50, Ill.	BT	General Radio Co.	Cambridge 39, Mass.
II	Dial Light Co. of America	Brooklyn 37, N. Y.	BU	Hughes Aircraft Co.	Culver City, Calif.
JJ	Leecraft Manufacturing Co.	New York, N. Y.	BV	International Rectifier Corp.	El Segundo, Calif.
KK	Switchcraft, Inc.	Chicago 22, Ill.	BW	James Knights Co.	Sandwich, Ill.
LL	Gremar Manufacturing Co.	Wakefield, Mass.	BX	Mueller Electric Co.	Cleveland, Ohio
MM	Carad Corp.	Redwood City, Calif.	BY	Precision Thermometer & Inst. Co.	Philadelphia 30, Pa.
NN	Electra Manufacturing Co.	Kansas City, Mo.	BZ	Radio Essentials Inc.	Mt. Vernon, N. Y.
OO	Acro Manufacturing Co.	Columbus 16, Ohio	CA	Raytheon Manufacturing Co.	Newton, Mass.
PP	Alliance Manufacturing Co.	Alliance, Ohio	CB	Tung-Sol Lamp Works, Inc.	Newark 4, N. J.
QQ	Arco Electronics, Inc.	New York 13, N. Y.	CD	Varian Associates	Palo Alto, Calif.
RR	Astron Corp.	East Newark, N. J.	CE	Victory Engineering Corp.	Union, N. J.
SS	Axel Brothers Inc.	Long Island City, N. Y.	CF	Weckesser Co.	Chicago 30, Ill.
TT	Belden Manufacturing Co.	Chicago 44, Ill.	CG	Wilco Corporation	Indianapolis, Ind.
UU	Bird Electronics Corp.	Cleveland 14, Ohio	CH	Winchester Electronics, Inc.	Santa Monica, Calif.
VV	Barber Colman Co.	Rockford, Ill.	CI	Malco Tool & Die	Los Angeles 42, Calif.
WW	Bud Radio Inc.	Cleveland 3, Ohio	CJ	Oxford Electric Corp.	Chicago 15, Ill.
XX	Allen D. Cardwell Mfg. Co.	Plainville, Conn.	CK	Camloc-Fastener Corp.	Paramus, N. J.
YY	Cinema Engineering Co.	Burbank, Calif.	CL	George K. Garrett	Philadelphia 34, Pa.
ZZ	Any brand tube meeting RETMA standards.		CM	Union Switch & Signal	Swissvale, Pa.
AB	Corning Glass Works	Corning, N. Y.	CN	Radio Receptor	New York 11, N. Y.
AC	Dale Products, Inc.	Columbus, Neb.	CO	Automatic & Precision Mfg. Co.	Yonkers, N. Y.
AD	The Drake Mfg. Co.	Chicago 22, Ill.	CP	Bassick Co.	Bridgeport 2, Conn.
AE	Elco Corp.	Philadelphia 24, Pa.	CQ	Birnbach Radio Co.	New York 13, N. Y.
AF	Hugh H. Eby Co.	Philadelphia 44, Pa.	CR	Fischer Specialties	Cincinnati 6, Ohio
AG	Thomas A. Edison, Inc.	West Orange, N. J.	CS	Telefunken (c/o MYM, Inc.)	New York, N. Y.
AH	Fansteel Metallurgical Corp.	North Chicago, Ill.	CT	Potter-Brumfield Co.	Princeton, Ind.
AI	General Ceramics & Steatite Corp.	Keasbey, N. J.	CU	Cannon Electric Co.	Los Angeles, Calif.
AJ	The Gudeman Co.	Sunnyvale, Calif.	CV	Dynac, Inc.	Palo Alto, Calif.
			CW	Good-All Electric Mfg. Co.	Ogallala, Nebr.

CLAIM FOR DAMAGE IN SHIPMENT

The instrument should be tested as soon as it is received. If it fails to operate properly, or is damaged in any way, a claim should be filed with the carrier. A full report of the damage should be obtained by the claim agent, and this report should be forwarded to us. We will then advise you of the disposition to be made of the equipment and arrange for repair or replacement. Include model number and serial number when referring to this instrument for any reason.

WARRANTY

Hewlett-Packard Company warrants each instrument manufactured by them to be free from defects in material and workmanship. Our liability under this warranty is limited to servicing or adjusting any instrument returned to the factory for that purpose and to replace any defective parts thereof. Klystron tubes as well as other electron tubes, fuses and batteries are specifically excluded from any liability. This warranty is effective for one year after delivery to the original purchaser when the instrument is returned, transportation charges prepaid by the original purchaser, and when upon our examination it is disclosed to our satisfaction to be defective. If the fault has been caused by misuse or abnormal conditions of operation, repairs will be billed at cost. In this case, an estimate will be submitted before the work is started.

If any fault develops, the following steps should be taken:

1. Notify us, giving full details of the difficulty, and include the model number and serial number. On receipt of this information, we will give you service data or shipping instructions.
2. On receipt of shipping instructions, forward the instrument prepaid, to the factory or to the authorized repair station indicated on the instructions. If requested, an estimate of the charges will be made before the work begins provided the instrument is not covered by the warranty.

SHIPPING

All shipments of Hewlett-Packard instruments should be made via Truck or Railway Express. The instruments should be packed in a strong exterior container and surrounded by two or three inches of excelsior or similar shock-absorbing material.

DO NOT HESITATE TO CALL ON US

HEWLETT-PACKARD COMPANY

Laboratory Instruments // *for Speed and Accuracy*

275 PAGE MILL ROAD

PALO ALTO, CALIF. U.S.A.

CABLE



"HEWPACK"

